

Name: _____
Date: _____
Track: _____

Diff. Oil
Front: _____
Center: _____
Rear: _____

Track Conditions
Size: Open Med. Tight
Traction: High Med. Low
Surface: Smooth Med. Bumpy

Tire
Front Type: _____
Front Foam: _____
Rear Type: _____
Rear Foam: _____

Engine
Type: _____ Muffler: _____
Gasket: _____ mm Fuel: _____
Plug: _____

Clutch
Clutch shoes: _____
Spring: _____ mm
Clutch bell / Spur gear: _____

Front Suspension

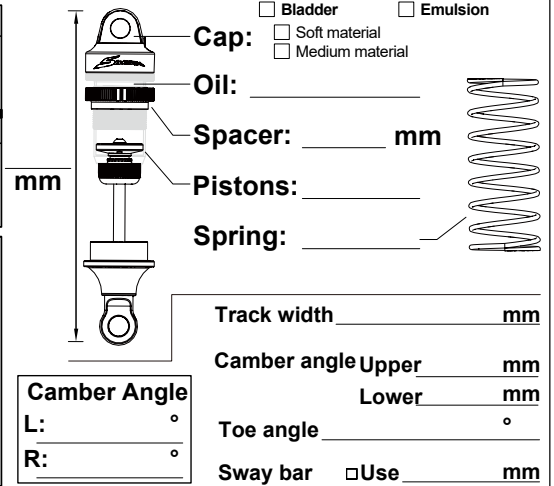
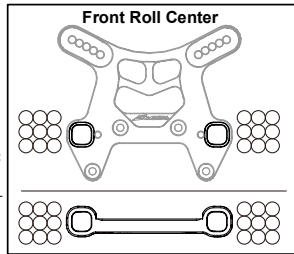
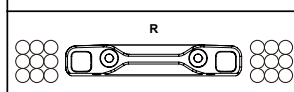
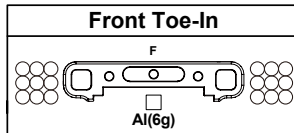
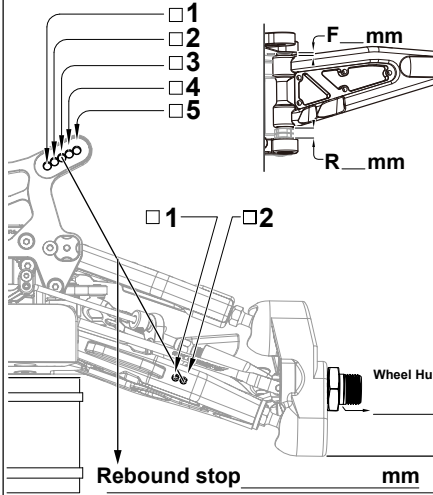

Rear Suspension

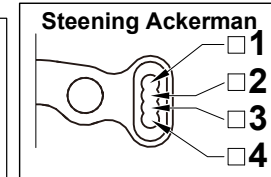
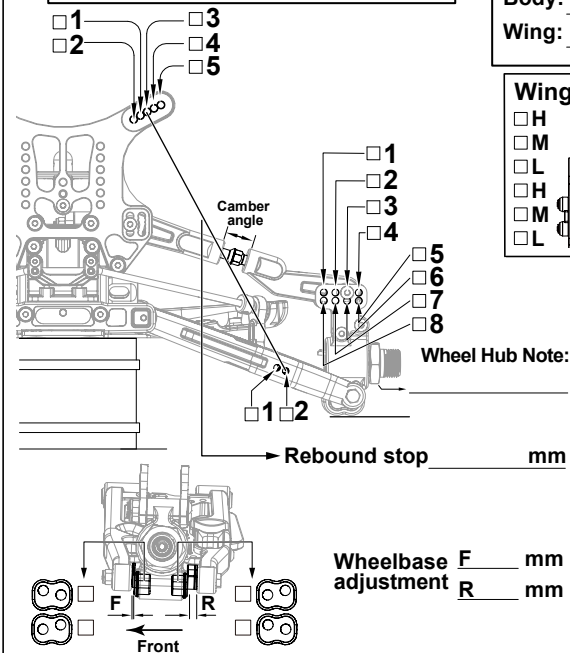
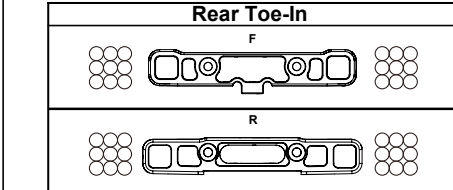

Body: _____
Wing: _____

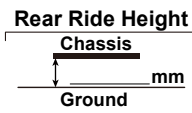
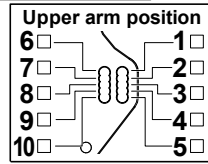
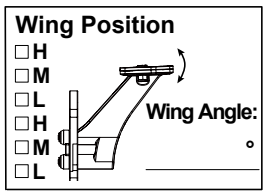

A Brass(15g) x _____
B Brass(15g) x _____
C Brass(15g) x _____

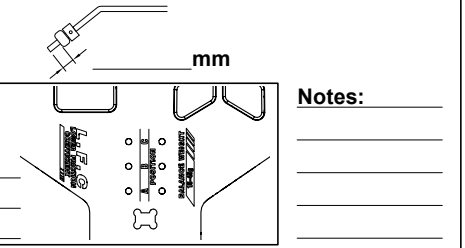
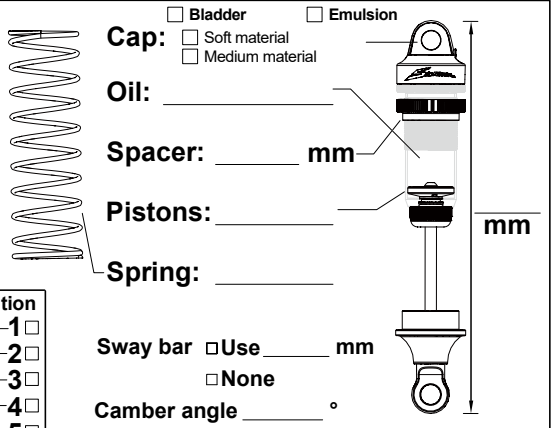
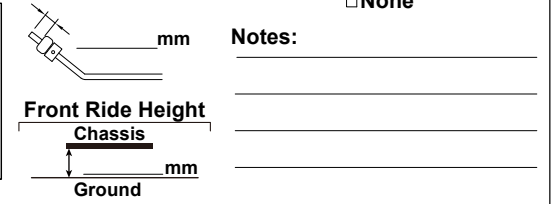

Option Parts List

Front Upper Arm
 Hard Soft
Carbon Cover _____ mm

Front Lower Arm
 Hard Medium Soft
Carbon Cover _____ mm

Rear Lower Arm
 Hard Medium Soft
Carbon Cover _____ mm