

Race time / Lap: _____

Best lap: _____

Name: _____
 Date: _____
 Track: _____

Diff. Oil
 Front: _____
 Center: _____
 Rear: _____

Track Conditions
 Size: Open Med. Tight
 Traction: High Med. Low
 Surface: Smooth Med. Bumpy

Tire
 Front Type: _____
 Front Foam: _____
 Rear Type: _____
 Rear Foam: _____

Electric System
 ESC Type: _____
 Motor Type: _____
 Motor Gear/Spur Gear: _____
 Battery Type A: Standard Pack _____
 Battery Type B: Shorty Pack _____

Front Suspension

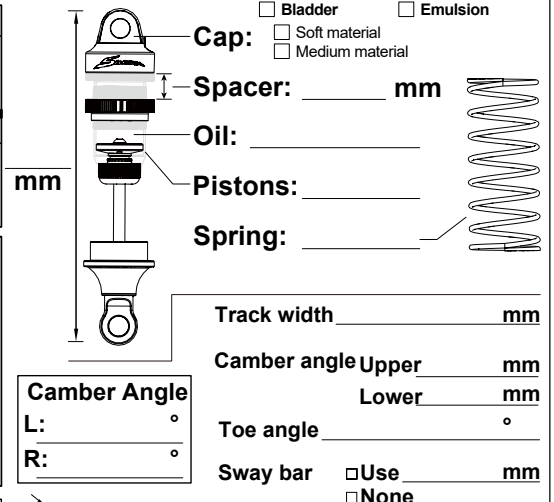
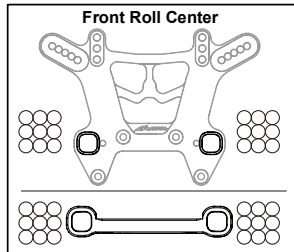
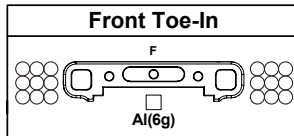
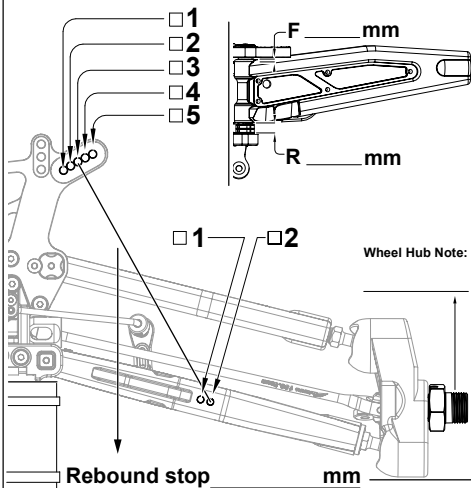

Rear Suspension

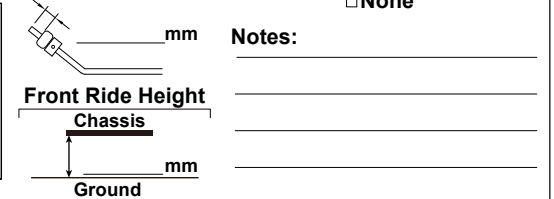
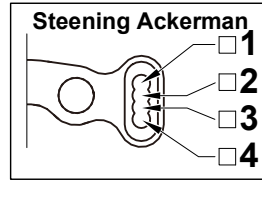
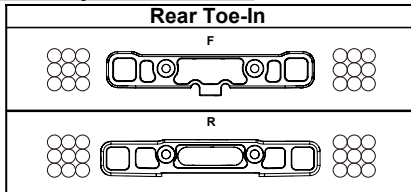
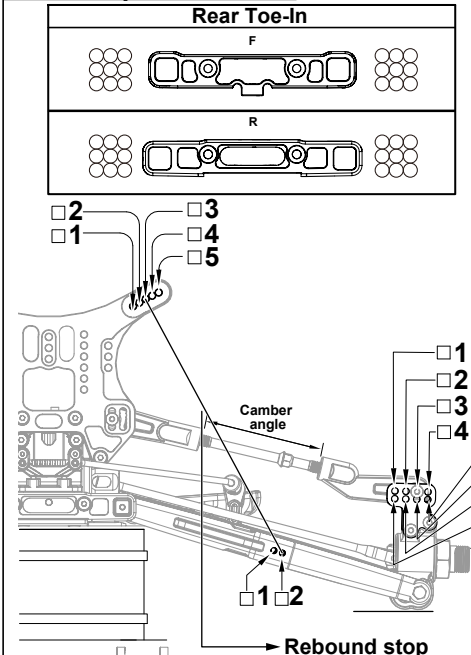

Body: _____
 Wing: _____

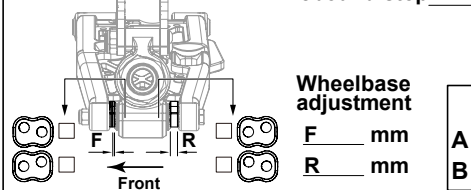
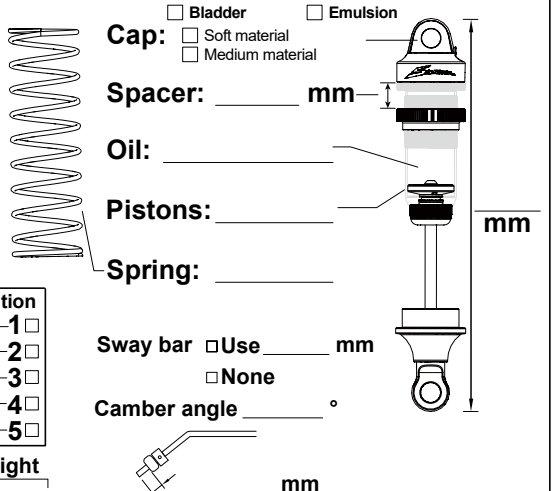
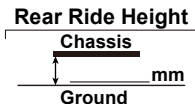
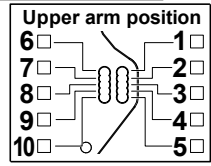
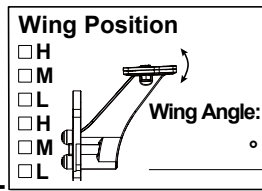

A Brass(15g) x _____
 B Brass(15g) x _____
 C Brass(15g) x _____
 D Brass(15g) x _____
 E Brass(15g) x _____

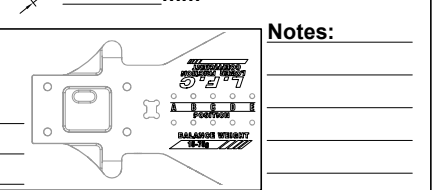

Option Parts List

Front Upper Arm

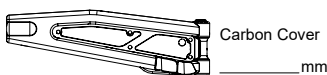

Front Lower Arm

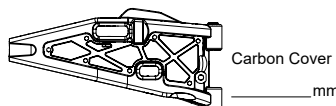

Rear Lower Arm

