

Name: _____ Date: _____ Event: _____

Track: INDOOR OUTDOOR Size: SMALL MEDIUM LARGE Traction: LOW MEDIUM HIGH

Surface: SMOOTH BUMPY RUTTED Type: LOOSE / LOAMY HARD PACKED BLUE GROOVE CLAY ASTRO

Bumpsteer/Ackerman/Servo Saver/Steering Stop: _____ Condition: DUSTY DRY WET MUDDY

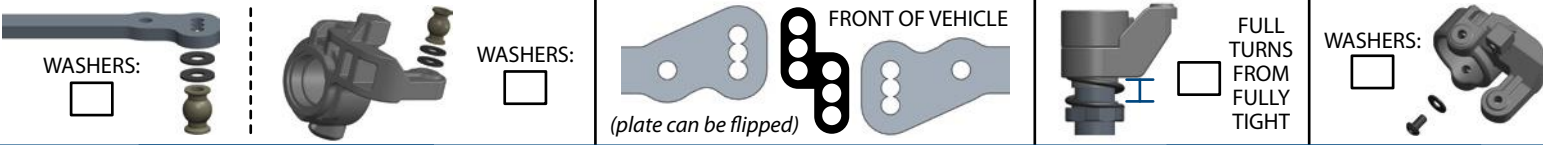

Front End:

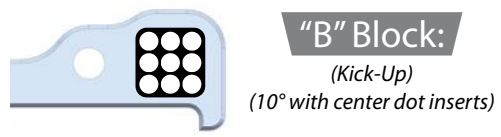
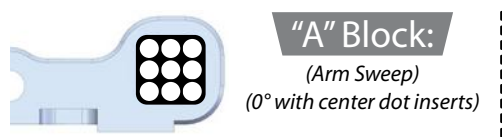
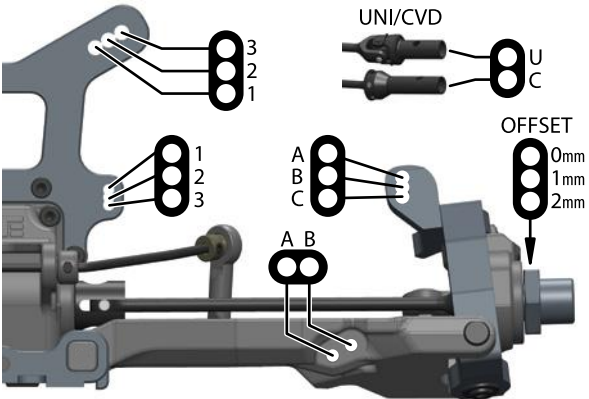

Suspension:

RIDE HEIGHT:	CAMBER:
CASTER BLOCK:	SWEEP:
KICK UP:	TOE:
SWAY BAR:	DROOP:

Shocks:

OIL:	BRAND:
PISTON:	SPRING:
REBOUND:	BUILD:

Differential Oil:

FRONT	CENTER	REAR
/	/	/
Drivetrain:		
PINION / SPUR:	/	(teeth)
Equipment:		

ESC: _____
 BATTERY: _____
 MOTOR: _____
 SERVO: _____

Chassis Braces:

CENTER DIFF: REAR:
 BATTERY INNER: BATTERY OUTER:

Tires / Wheels:

BRAND / TREAD: _____
 COMPOUND: _____
 INSERT: _____
 WHEEL: _____
 NOTES: _____

Body / Wing:

BODY MAKE: _____
 WING MAKE: _____

Notes:

Rear End:

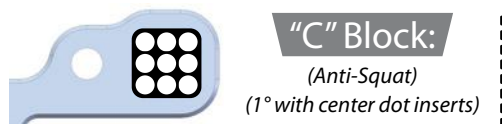
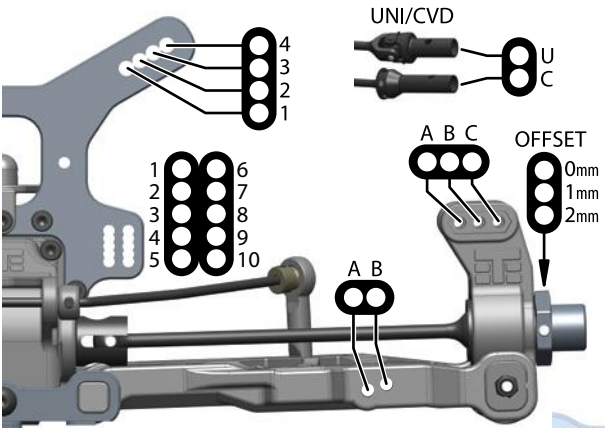

Suspension:

RIDE HEIGHT:	CAMBER:
ANTI-SQUAT:	TOE:
SWAY BAR:	DROOP:

Shocks:

OIL:	BRAND:
PISTON:	SPRING:
REBOUND:	BUILD:

Arm Inserts:

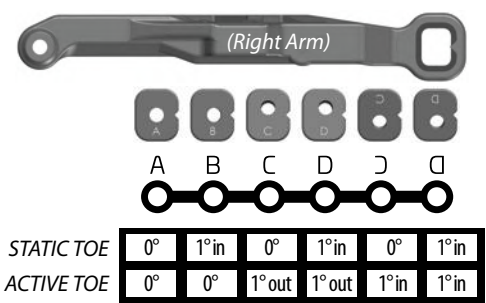

Rear Hub / Wheelbase:

